

# AC Rectifier CBCx-001

## Installation & Operation Manual

P-2100-WE  
CBCx-001





An **Altra Industrial Motion** Company

## Function

The CBCx-001 power supply is an AC rectifier providing a time programmable Over-excitation voltage as well as an integrated On/Off switch. This is particularly suitable to all Power-Off applications based on our well known Elevator Brakes, ERD or ERS brakes.

The Over-excitation feature is automatically switching from a Full bridge to a single wave rectification after a programmable time (from 50 ms up to 4 s). It can easily be disabled to convert your power supply in a Single or Double wave rectifier. The On/Off Control allows this power supply to be driven directly thru an external PLC or Control board. Thanks to its integrated PNP input, the power can be directly applied or removed without using any external Switches or Relays. The DC power-off feature associated to the state of the art snubber design allows drastic reduction of the engagement time requested by most of the security related applications.

## Ratings

<b>Input Voltage</b>	100 VAC to 500 VAC (+/- 10%) 50 – 60 Hz
<b>Output Voltage</b>	90 VDC to 450 VDC
<b>Maximum Output Current</b>	5 Amps max (See below conditions)
<b>Over-Excitation</b>	Integrated programmable timer (from 50 ms to 4 s)
<b>ON/OFF Control</b>	Integrated PNP Input (8 to 30 VDC). (can be disabled)
<b>Shorter Response time DC switch off</b>	Integrated back EMF suppression
<b>Certifications</b>	CE, UL approved
<b>Operating T°C</b>	-25°C to 70°C no Condensation (Check below instructions for more details)
<b>Compliance</b>	  

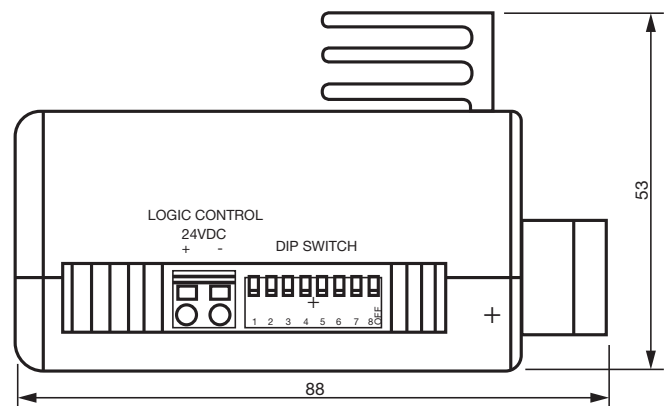
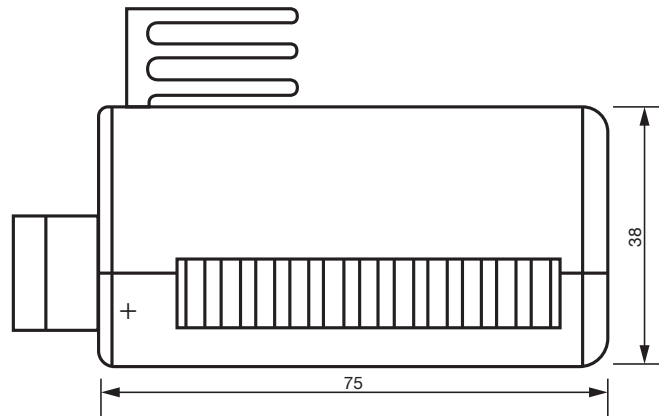
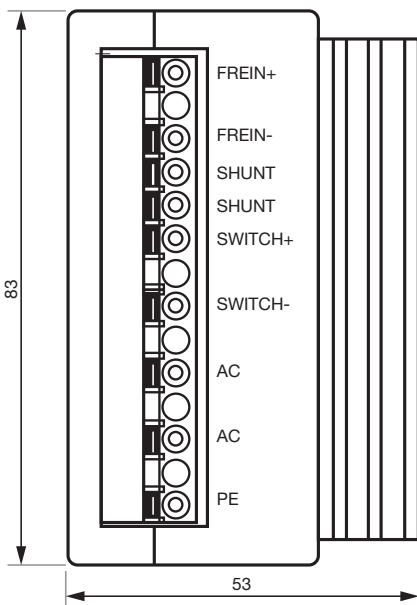

## General information

Power supply enclosure should be kept clear of all areas where foreign material, dust, grease, or all might affect the operation of the control.

Installation must be made in accordance with the instructions found in this manual. Failure to do so may damage the Power supply.

## Electrical Connection

1	DC BRAKE +	Power Output	Output contact to the Clutch/Brake Coil. DC Power output : 90 VDC to 450 VDC.
2	DC BRAKE -	Power Output	Output contact to the Clutch/Brake Coil.
3	SHUNT+	Accessory	Current Sensing. Contact which allows the opening of the power supply DC Side to integrate a current sensing or over measuring instrument. One can add a Hall effect current probe for instance. Default : When not used, a Short circuit bridge is needed between pins 3 and 4.
4	SHUNT-	Accessory	Current Sensing.
5	DC SWITCH +	Accessory	DC switching off. Use to Power off the brake with a Fast Response Time : Emergency stop for instance. Default : When not used, a Short circuit bridge is needed between pins 5 and 6.
6	DC SWITCH -	Accessory	DC switching off.
7	AC	Power Input	AC power Input : 90VAC to 500VAC
8	AC	Power Input	AC power Input : 90VAC to 500VAC
9	PE	Protective Earth	This terminal is usually connected to earth provided by the AC grid.

Logical Control 1	ON/OFF +	Digital input	Logic Control. 24V PNP input. When High, powers up the brake. This power up will be made on the AC side, with offering If over-excitation feature is enabled, then over-excitation voltage is applied during the programmed time. Active High/GND: PNP type Input.
Logical Control 2	Ground	Digital input	Ground

**Synoptic:**

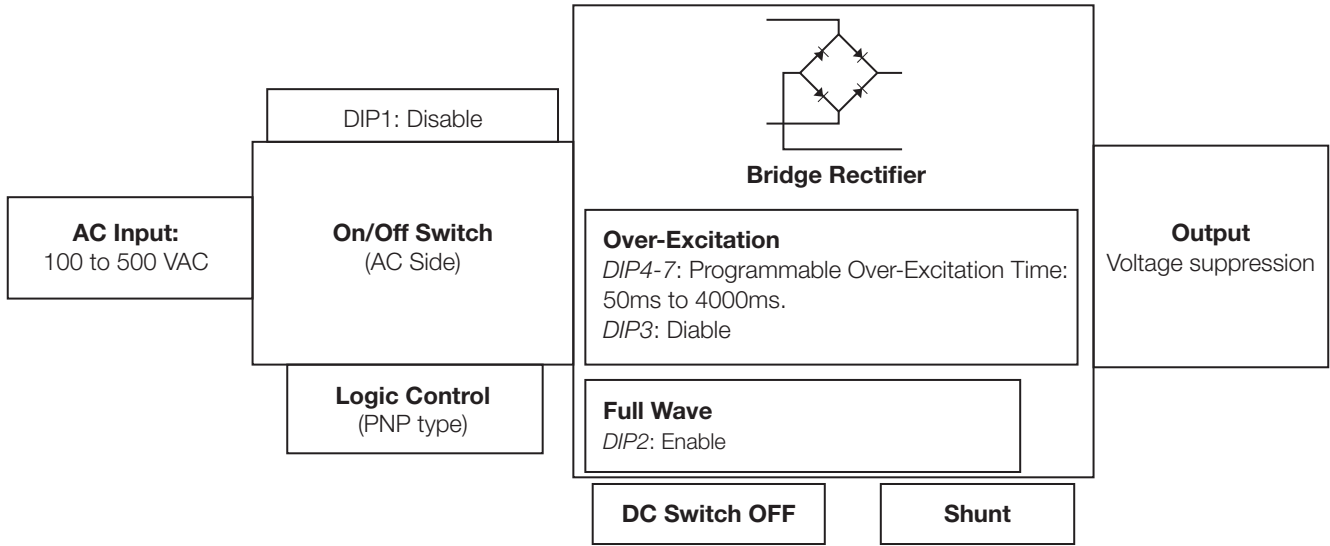

**Technical Data**

<b>Input Voltage</b>		100 VAC to 500 VAC (+/- 10%) 50 – 60 Hz
<b>Output Voltage</b>		90 VDC to 450 VDC
	With Over-excitation	$U_{Brake} (VDC) = 0,9 \times U_{AC}$ (Limited to the selected over-excitation time)
	Full Wave	$U_{Brake} (VDC) = 0,9 \times U_{AC}$
	Half Wave (Holding voltage)	$U_{Brake} (VDC) = 0,45 \times U_{AC}$
	Max T °C	
<b>Output Current</b>	70°C	2 Amps Over-excitation (double Wave) / 1 Amps Holding (Single Wave)
	60°C	3 Amps Over-excitation (double Wave) / 1.5 Amps Holding (Single Wave)
	50°C	5 Amps Over-excitation (double Wave) / 2.5 Amps Holding (Single Wave)

## DIP Switch selection

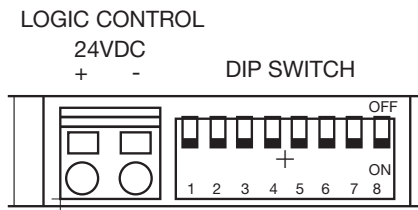

<b>DIP1</b>	if ON	PNP Logic control input <b>disabled</b>								
<b>DIP2</b>	if ON	Full Wave <b>forcing</b> If ON, Over-excitation is always enabled.								
<b>DIP3</b>	if ON	Over-excitation <b>Disabled</b>								
		50ms	100ms	150ms	500ms	1000ms (Default)	1500ms	2000ms	3000ms	4000ms
<b>DIP4</b>	ON	ON	ON	ON	ON	ON	ON	ON		
<b>DIP5</b>	ON	ON		ON	ON				ON	
<b>DIP6</b>	ON		ON	ON		ON				
<b>DIP7</b>				ON	ON	ON	ON	ON	ON	ON
<b>DIP8</b>	Not used									

## Examples

**AC switching with external contactor (not supplied) / 24VDC PNP Control not used / 1s Over-excitation:**

<b>DIP1:</b>	ON	<b>DIP2:</b>	OFF	<b>DIP3:</b>	OFF	<b>DIP4:</b>	ON	<b>DIP5:</b>	ON	<b>DIP6:</b>	OFF	<b>DIP7:</b>	ON
--------------	----	--------------	-----	--------------	-----	--------------	----	--------------	----	--------------	-----	--------------	----

**24VDC PNP Control Enabled / 500ms Over-excitation:**

<b>DIP1:</b>	OFF	<b>DIP2:</b>	OFF	<b>DIP3:</b>	OFF	<b>DIP4:</b>	ON	<b>DIP5:</b>	ON	<b>DIP6:</b>	ON	<b>DIP7:</b>	ON
--------------	-----	--------------	-----	--------------	-----	--------------	----	--------------	----	--------------	----	--------------	----

**AC switching with external contactor (not supplied) / 24VDC PNP Control not used / Full wave control (no Over-excitation):**

<b>DIP1:</b>	ON	<b>DIP2:</b>	ON	<b>DIP3:</b>	NA	<b>DIP4:</b>	NA	<b>DIP5:</b>	NA	<b>DIP6:</b>	NA	<b>DIP7:</b>	NA
--------------	----	--------------	----	--------------	----	--------------	----	--------------	----	--------------	----	--------------	----

**AC switching with external contactor (not supplied) / 24VDC PNP Control not used / Half wave control :**

<b>DIP1:</b>	ON	<b>DIP2:</b>	OFF	<b>DIP3:</b>	ON	<b>DIP4:</b>	NA	<b>DIP5:</b>	NA	<b>DIP6:</b>	NA	<b>DIP7:</b>	NA
--------------	----	--------------	-----	--------------	----	--------------	----	--------------	----	--------------	----	--------------	----

## Installation

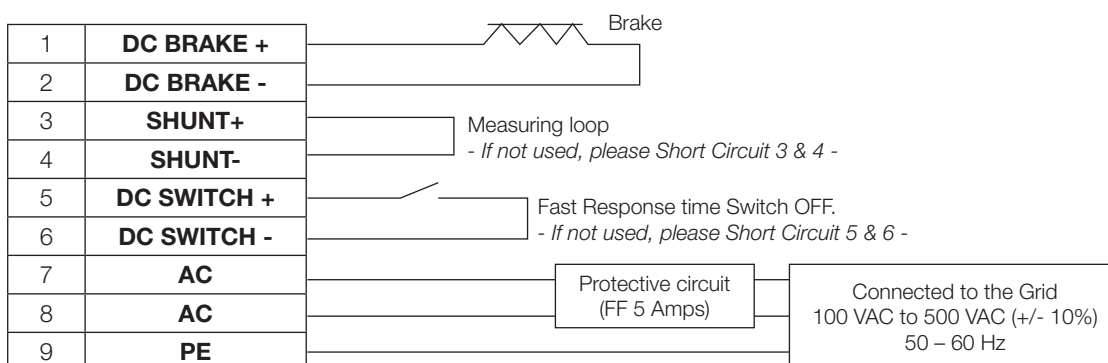



[www.warnerelectric.com](http://www.warnerelectric.com)

7, rue Champfleu, B.P. 20095  
St Barthelemy d'Anjou - France  
+33 (0)2 41 21 24 24  
Fax: +33 (0)2 41 21 24 70

An **Altra Industrial Motion** Company

