

M-Track 1

DC Motor Acme Screw



Up to 165 lb. (734 N) Rated Load
Up to 1.75 in. (45 mm)/sec. Travel Speed

M-Track 1 compact units are completely self-contained and sealed to allow use in small spaces without sacrificing power or capability. The load and length capabilities provide solutions for a diverse range of intermittent duty applications.

Functionally, M-Track 1 actuators are easily interchanged with comparable size hydraulic or pneumatic cylinders on intermittent duty applications. The actuator provides consistent, repeatable performance even for applications with operating conditions including temperature extremes, high humidity, or significant dust.

Features

- **An Acme Screw** drive delivers up to 165 pounds (734 N) of force at a minimum extension rate of 0.25 inches (6.35 millimeters) per second.
- **The anodized aluminum alloy** housing resists corrosion and provides protection from dirt, dust and humidity.
- **Temperature operating range** of -20° F to +150° F (-26° to +65° C). -40° F to +185° F (-40° to +80° C) available.
- **Standard stroke lengths** of 1, 2, 4, 6, 8, 10, 12 inches (50, 100, 150, 200, 254, 300 millimeters) are available.
- **Internal limit switches** automatically shut off the unit at end of stroke.
- **Optional potentiometer** can provide positional location feedback.
- **IP69K Static, IP65 Dynamic**
- **Temporary Immersion** with protective boot (see page 10).
- **Rod is non rotating** during operation, can be rotated for mounting purposes.

Typical Applications

Light load and short distance applications such as:

- **Valve and vent** adjustments
- **Light weight** tilt or lift positioning
- **Vise and clamp** operations

Specifications				
Load Capacity	25 lbs. (111 N)	50 lbs. (222 N)	100 lbs. (445 N)	165 lbs. (734 N)
Speed at Full Load	1.75 in. (45 mm)/sec	0.80 in. (20 mm)/sec	0.45 in. (11 mm)/sec	0.25 in. (6 mm)/sec
Input Voltage	12 or 24 volt DC for all models			
Static Load Capacity	300 lbs. (135 N) for all models			
Stroke Length	1, 2, 4, 6, 8, 10 and 12 in. (50, 100, 150, 200, 254, 300 mm) for all models			
Clevis Ends	.25 in. (6.4 mm) diameter			
Duty Cycle	25% for all models			
Operation Temperature Range	-20° F to +150° F (-26° to + 65° C) for all models, -40° F to +185° F (-40° C to +80° C) available			
Environment	IP65 Dynamic, IP69K and Temporary Immersion with Protective Boot			
Limit Switch	Fixed end of stroke limit switches standard for all units			
Potentiometer	Linear membrane potentiometer optional on all units			

Dimensions

M-Track	Stroke	in.	mm	in.	mm	in.	mm	in.	mm	in.	mm	in.	mm
		2	50	4	100	6	150	8	200	10	254	12	300
	A (w/o POT)	6.22	158.0	8.23	209.0	10.24	260.1	12.24	310.9	14.25	362.0	16.26	413.0
	A (POT)	7.55	191.8	9.57	243.1	11.57	293.9	13.58	344.9	15.58	395.7	17.58	446.5

Note: Special lengths available; metric stroke length for reference only

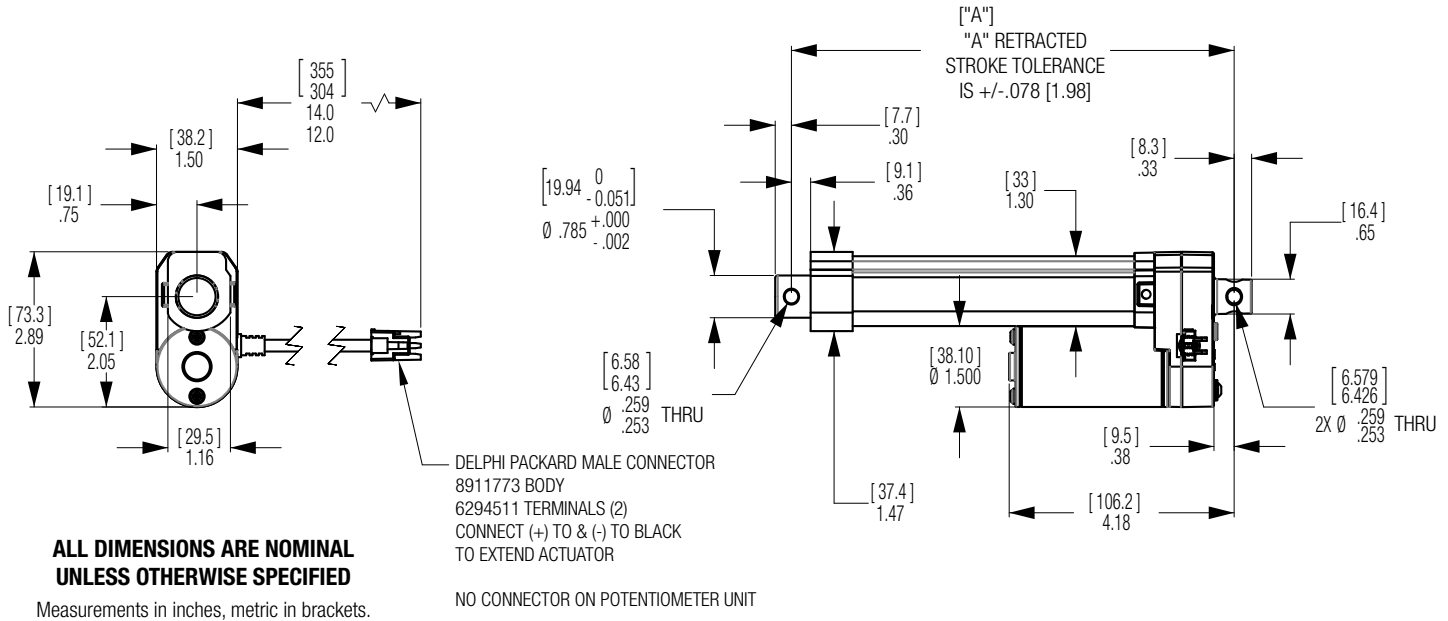

- Stroke and its tolerance are based on a unit with no attached load operating at rated voltage +/- .5VDC, 70° F controlled temperature environment. Note normal wear, temperature changes and load variations all affect the stroke tolerance. If stroke tolerance is critical it is advisable that the selected unit be evaluated for performance in the specific application.
- The retract pin to pin dimension and its tolerance are based on a unit with no attached load operating at rated voltage +/- .5VDC, 70° F controlled temperature environment. Note normal unit wear, temperature changes and load variations all affect the stroke tolerance. If the retract pin to pin dimension is critical it is advisable that the selected unit be evaluated for performance in the specific application.
- Rotation of the extension tube is allowed up to one full turn to aid mounting. Rotate rod clockwise until it is fully seated in the unit. Rotate counterclockwise no more than one full turn to align clevis pins.

- Mounting points in the application must allow the actuator to reach full-extend and full-retract to ensure the internal limit switches are activated. If this is not possible another method for shutting off the actuator must be employed.
- If the actuator encounters an obstruction at mid-stroke and is not allowed to reach the internal limit switches the actuator will stall. An internal thermal circuit breaker is designed to protect the motor from damage during stalling and/or overheating due to exceeding duty cycle. If tripped it will self reset after a short period of time. The thermal is rated to protect the motor in the event of a stall condition. It is not designed to protect any other device in the circuit.
- Warner Linear recommends an externally mounted fuse of 6 AMPs max for 12VDC and 3 AMPs max for 24VDC circuit protection. Anything connected to the actuator must be sized to withstand the actuator's power consumption or independently isolated from the circuit.

M-Track 1 with Protective Boot

For Rubber Bellow Application



Features

- All features as M-Track
- Protective Boot for temporary immersion

Typical Applications

Light load and short distance applications such as:

- UTV differential locks
- Transmission Shifting

Dimensions		in.	mm	in.	mm	in.	mm	in.	mm	in.	mm	in.	mm
M-Track with Boot LN/LP	Stroke	2	50	4	100	6	150	8	200	10	254	12	300
	A	9.48	241	9.48	241	11.48	292	13.48	342	15.48	393	17.48	444
	B	11.48	292	13.48	342	17.48	444	21.48	546	25.48	647	29.48	749

Note: Special lengths available

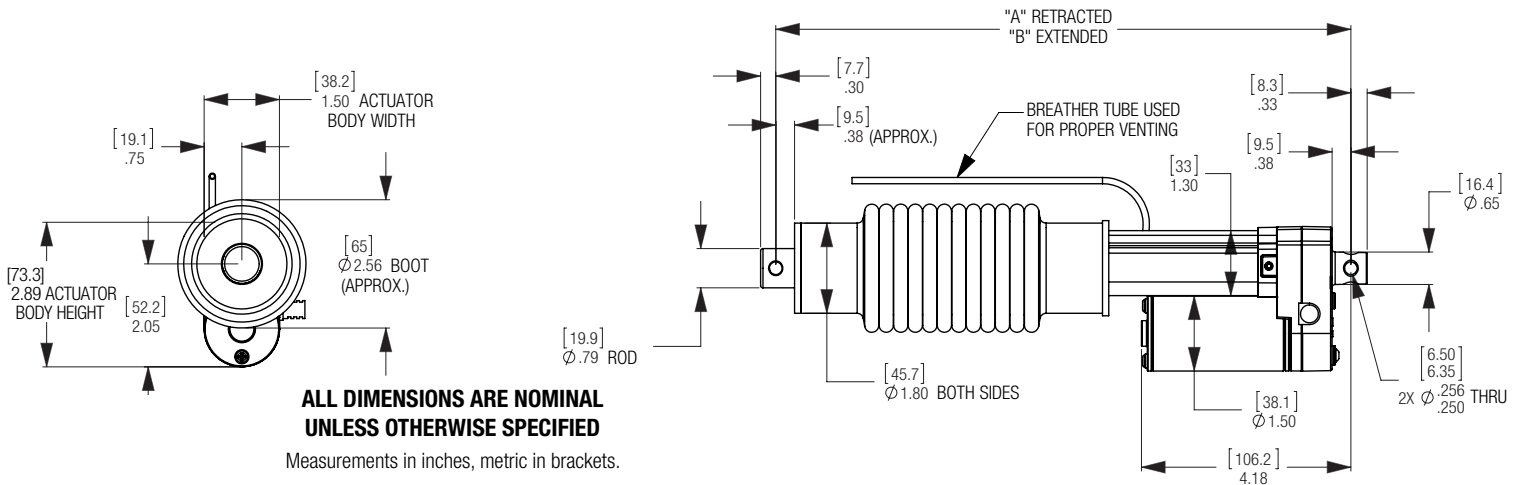

NOTE: 2" Stroke Length unavailable with a Rubber Boot.
Alternate method is to use 4" Stroke with 2" Limits

Performance Graphs Imperial Measurements*

*Performance Chart Measurements are Nominal



Load Capacity 25 lbs.

For Metric Measurements, see page 12.

M1-D012-0025

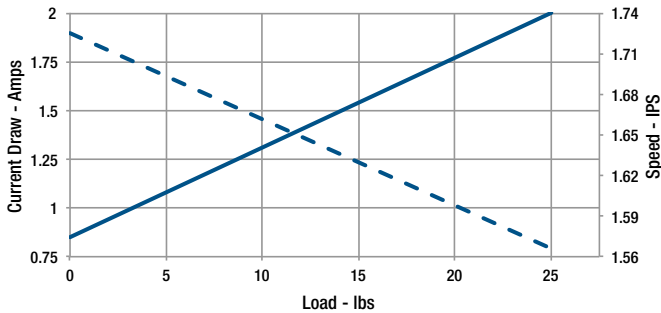

M1-D024-0025

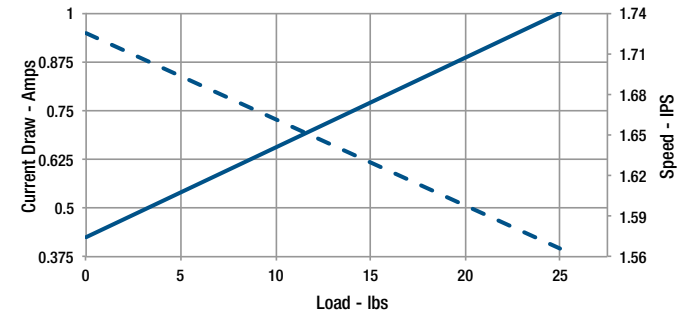

Load Capacity 50 lbs.

For Metric Measurements, see page 12.

M1-D012-0050

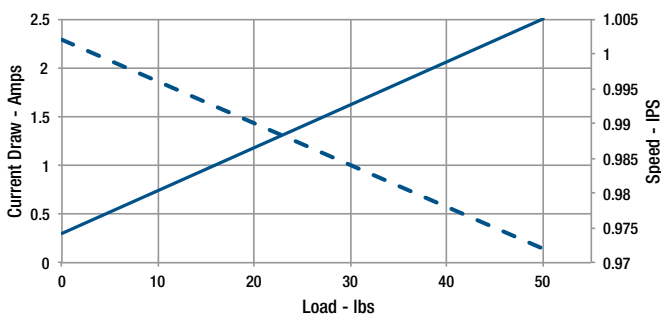

M1-D024-0050

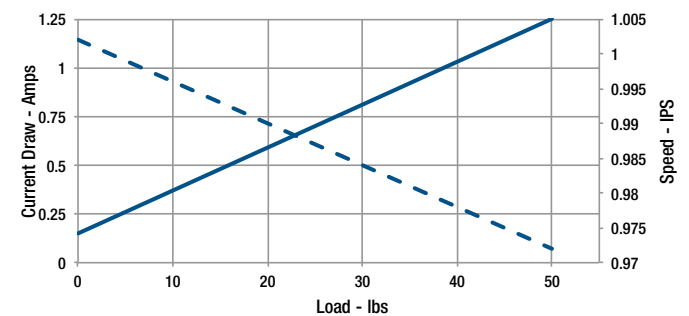

Load Capacity 100 lbs.

For Metric Measurements, see page 12.

M1-D012-0100

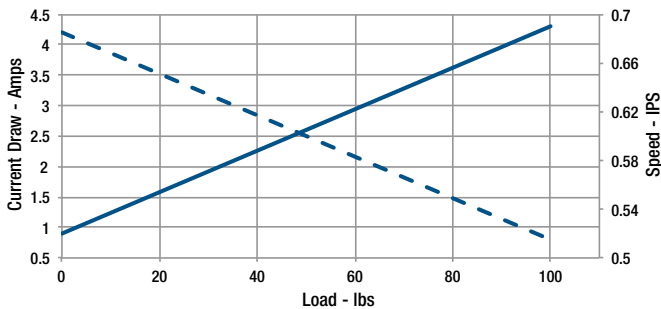

M1-D024-0100

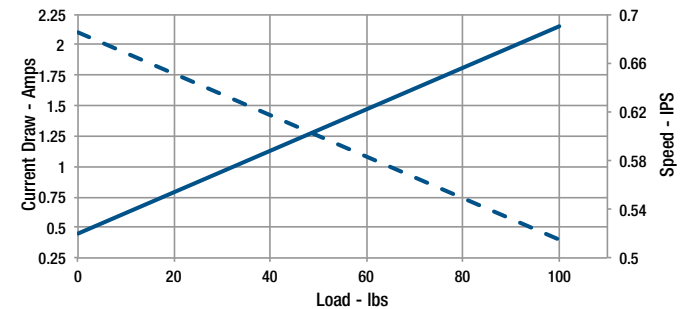

Load Capacity 165 lbs.

For Metric Measurements, see page 12.

M1-D012-0165

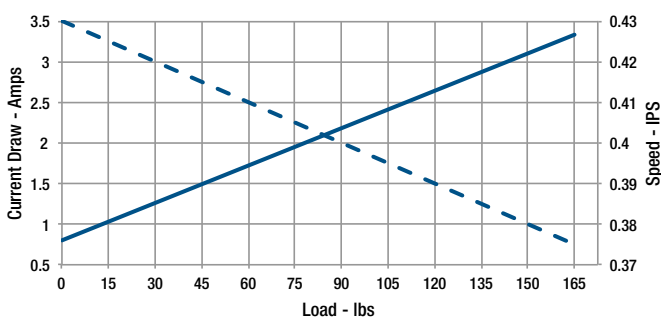

M1-D024-0165

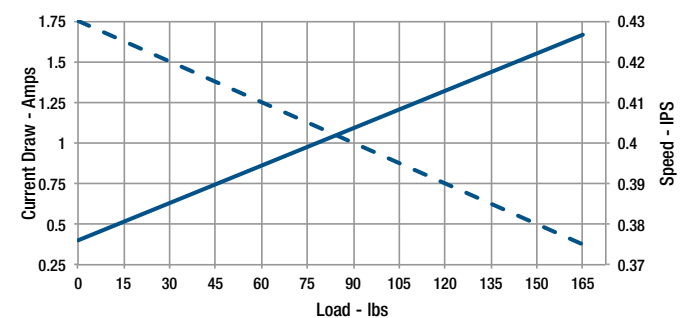

M-Track 1

Performance Graphs Metric Measurements*

*Performance Chart Measurements are Nominal



Load Capacity 111 N

For Imperial Measurements, see page 11.

M1-D012-0025

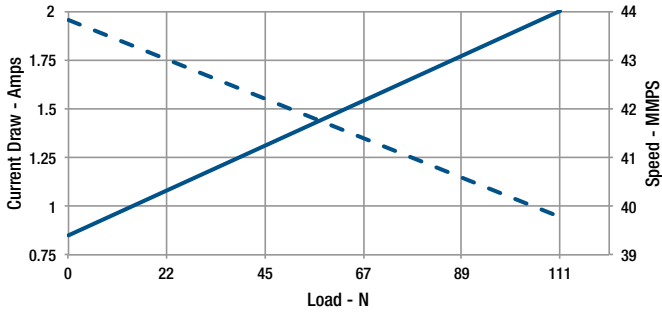

M1-D024-0025

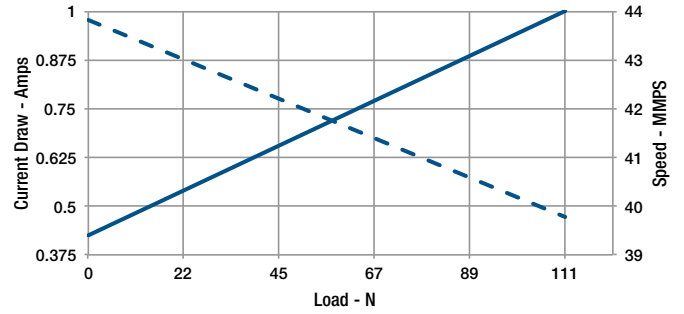

Load Capacity 223 N

For Imperial Measurements, see page 11.

M1-D012-0050

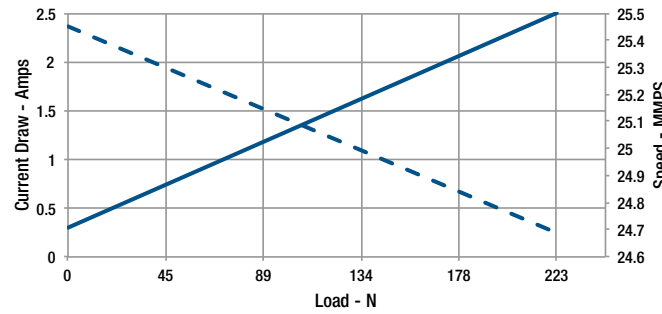

M1-D024-0050

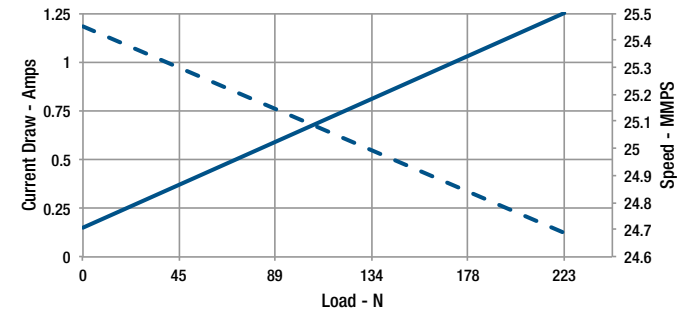

Load Capacity 445 N

For Imperial Measurements, see page 11.

M1-D012-0100

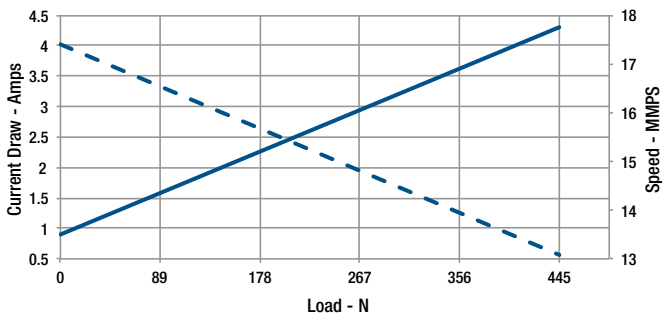

M1-D024-0100

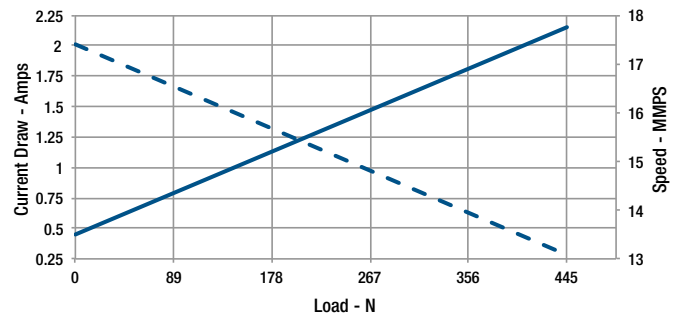

Load Capacity 734 N

For Imperial Measurements, see page 11.

M1-D012-0165

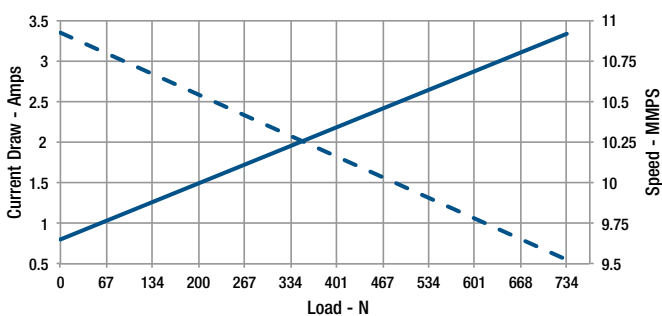

M1-D024-0165

