

Backstopping Clutches

HSB (High Speed Backstops)

Backstopping Ball Bearing Supported, Sprag Clutches



Combination sprag clutch and oil reservoir Holdback conveyors and reducers

HSB units are intended for use as backstops on the high speed shaft or intermediate shaft of a reducer, and as holdbacks on the head shaft of conveyors. They use standard clutches with the addition of the oil reservoir. The oil reservoir is an aluminum casting with cooling fins. HSB models have a spacer replacing the seal at the reservoir end to permit free oil flow between clutch and reservoir. The reservoir has a flush oil sight gauge and a filtered breather. Refer to Bore Sizes/Shaft Tolerance chart for mounting data, page 65. Standard keys supplied by Formsprag at no additional charge for models 750 through 1027.

A torque arm is required to prevent the outer race and reservoir from rotating, see page 124.

The FSO-400 through 700 and FS-750 through 1027 clutch assemblies that are used to make up the HSB series clutches are shipped from the factory with Mobil DTE Heavy Medium oil, but must be filled to the proper level before operation.

For further information, see Installation and Maintenance Bulletin No. 2214, P-222-7.

Specifications

Size	Torque Capacity lb.ft. (Nm)	Overrunning Speed Max. RPM	Resistance after run-in lb.ft. (Nm)	Lubrication Oil oz (ml)	Shipping Weight lb. (kg)
400	300 (408)	2,900	.20 (.27)	2 (59.1)	7 (3.2)
500	1,175 (1598)	2,650	.45 (.61)	3.5 (103.5)	12.5 (5.7)
600	2,250 (3060)	2,300	.90 (1.22)	6 (177.4)	20 (9)
700	5,000 (6800)	2,000	2.13 (2.89)	10 (295.7)	47 (21)
750	7,000 (9520)	1,800	3.75 (5.08)	20 (591.4)	88 (40)
800	13,000 (17,680)	1,400	5.25 (7.12)	25 (739.3)	112 (51)
900	18,000 (24,480)	1,300	6.25 (8.47)	30 (887.1)	170 (77)
1027	27,000 (36,720)	1,050	10.00 (13.56)	40 (1183.4)	315 (143)

Notes:

Check key and shaft stress before making final clutch selection since this may determine the maximum allowable drive torque capacity. Specify direction of rotation when ordering.

HSB-400 to 700 clutch assemblies are FSO clutches plus an HSB oil reservoir kit.

HSB-750 to 1027 clutch assemblies are FS clutches plus an HSB oil reservoir kit.

The reservoir kits are boxed separately.

Always consult the Installation and Maintenance Bulletin 2214, P-222-7 for the special seal modifications required to the FSO clutch when being used with the HSB oil reservoir kit, before attaching the reservoir.

Typical Mounting Arrangement

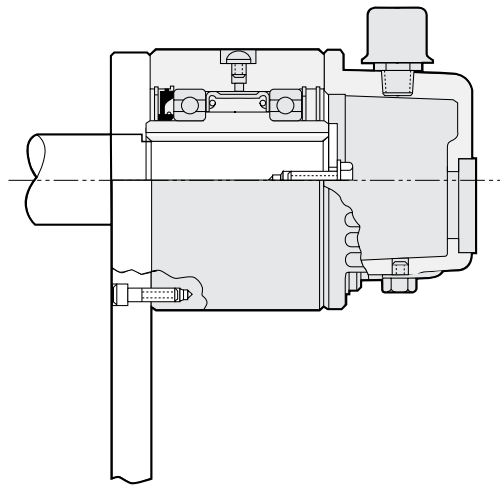

The Model HSB clutch with optional FSO Torque Arm, see Accessories, must be axially restrained on the shaft. The above typical drawing shows a customer supplied retaining plate and bolt and a stepped shaft, providing this restraint. All fasteners are recommended to be grade 8 bolts.

Backstopping Clutches

HSB (High Speed Backstops)

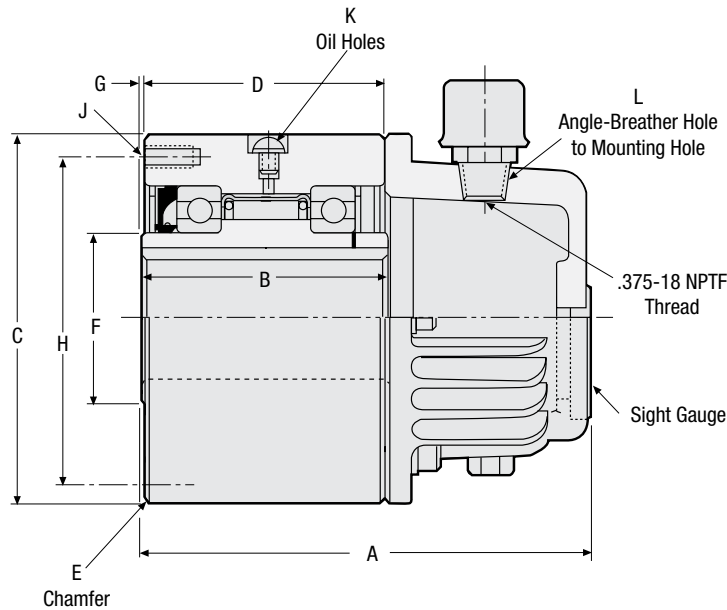

Dimensions inches (mm)

Size	A	B	C	D	E	F	G	H	J			K	L*
									Number	Thread	Depth		
400	4.78 (121.44)	2.75 (69.85)	3.500/3.498 (88.90/88.85)	2.69 (68.25)	.06 x 45° (1.57 x 45°)	1.19 (29.97)	.03 (.78)	2.88 (73.02)	4 @ 90°	.312-24	.50 (12.70)	.250-28	45°
500	6.50 (165.10)	3.50 (88.90)	4.250/4.248 (107.95/107.90)	3.38 (85.72)	.06 x 45° (1.57 x 45°)	1.19 (30.15)	.06 (1.57)	3.63 (92.07)	4 @ 90°	.312-24	.63 (15.87)	.250-28	45°
600	6.75 (171.45)	3.75 (95.25)	5.375/5.373 (136.52/136.47)	3.63 (92.07)	.06 x 45° (1.57 x 45°)	1.75 (44.45)	.06 (1.57)	4.75 (120.65)	6 @ 60°	.312-24	.63 (15.87)	.250-28	30°
700	9.00 (228.60)	5.00 (127.00)	7.125/7.123 (180.97/180.92)	4.88 (123.82)	.06 x 45° (1.57 x 45°)	3.56 (90.42)	.06 (1.57)	6.25 (158.75)	8**	.375-24	.75 (19.05)	.250-28	0° or 30°
750	11.00 (279.40)	6.00 (152.40)	8.750/8.748 (222.25/222.20)	5.88 (149.22)	.06 x 45° (1.57 x 45°)	4.25 (107.95)	.06 (1.57)	7.00 (177.80)	8**	.500-20	1.00 (25.40)	.500-20	0° or 30°
800	11.50 (292.10)	6.00 (152.40)	10.000/9.998 (254.00/253.95)	5.88 (149.22)	.06 x 45° (1.57 x 45°)	5.50 (139.70)	.06 (1.57)	8.94 (227.00)	8 @ 45°	.500-20	1.00 (25.40)	.500-20	0° or 45°
900	12.25 (311.15)	6.38 (161.92)	12.000/11.997 (304.80/304.72)	6.25 (158.75)	.06 x 45° (1.57 x 45°)	6.38 (161.92)	.06 (1.57)	9.75 (247.65)	10 @ 36°	.625-18	1.25 (31.75)	.500-20	0° or 18°
1027	12.68 (322.07)	6.63 (168.27)	15.000/14.997 (381.00/380.92)	6.50 (165.10)	.13 x 45° (3.17 x 45°)	9.00 (228.60)	.06 (1.57)	11.75 (298.45)	12 @ 30°	.625-18	1.00 (25.40)	.500-20	15°

* Angle-breather hole to mounting hole.

** Six holes equally spaced at 60° plus two extra holes at 180°. Six hardened mounting screws are adequate for torque loads up to 3,000 lb.ft. (4068 Nm) for model 700, or 5,100 lb.ft. (6916 Nm) for model 750; use eight hardened mounting screws for torque loads above these values.

Bore sizes and keyseats***† inches (mm)

Size	Bore Size	Keyseat	Bore Range	
			Min.	Max.
400	.500 (12.70)	1/8 x 1/16 (3.17 x 1.57)	.437 (11.10)	.875 (22.22)
	.625 (15.87)	3/16 x 3/32 (4.75 x 2.36)		
	.750 (19.05)			
500	.875 (22.22)	3/16 x 1/16 (4.75 x 1.57)	.750 (19.05)	1.312 (33.32)
	1.000 (25.40)			
	1.125 (28.57)	1/4 x 1/8 (6.35 x 3.17)		
	1.250 (31.75)			
600	1.312 (33.32)	1/4 x 3/32 (6.35 x 2.36)	.937 (23.80)	2.250* (57.15)
	1.250 (31.75)	1/4 x 1/8 (6.35 x 3.17)		
	1.375 (34.92)			
	1.500 (38.10)	3/8 x 3/16 (9.52 x 4.75)		
	1.625 (41.27)			
	1.750 (44.45)			
700	2.000 (50.80)	3/8 x 1/8 (9.52 x 3.17)	1.875 (47.62)	3.250** (82.55)
	1.937 (49.20)			
	2.000 (50.80)	1/2 x 1/4 (12.70 x 6.35)		
	2.250 (57.15)			
	2.437 (61.90)	5/8 x 5/16 (15.87 x 7.92)		
	2.500 (63.50)			
	2.750 (69.85)	5/8 x 7/32 (15.87 x 5.59)		
2.937 (74.60)	5/8 x 1/8 (15.87 x 3.17)			

* 1/2 x 1/8 keyway

** 3/4 x 1/4 keyway

*** For finished dimensions of keys supplied with the clutch, contact Formsprag.

† For Bore Sizes/Shaft Tolerances, see page 126.

Size	Bore Size	Keyseat	Bore Range	
			Min.	Max.
750	2.437 (61.90)	5/8 x 5/16 (15.87 x 7.92)	2.250 (57.15)	3.437 (87.30)
	2.500 (63.50)			
	2.750 (69.85)			
	2.937 (74.60)			
800	3.000 (76.20)	3/4 x 3/8 (19.05 x 9.52)	2.625 (66.67)	4.437 (112.70)
	3.250 (82.55)			
	3.437 (87.30)			
900	3.437 (87.30)	1 x 1/2 (25.40 x 12.70)	3.625 (92.07)	5.437 (138.10)
	3.500 (88.90)			
	3.750 (95.25)			
	3.937 (100.00)			
	4.000 (101.60)			
	4.250 (107.95)			
1027	4.437 (112.70)	1 1/4 x 5/8 (31.75 x 15.87)	4.937 (125.40)	7.000 (177.80)
	4.437 (112.70)			
	4.500 (114.30)			
	4.750 (120.65)			
	4.937 (125.40)			
	5.000 (127.00)			
	5.250 (133.35)			
5.437 (138.10)				
1077	4.937 to 6.000 (125.40 to 152.40)	1 1/2 x 1/2 (38.10 x 12.70)	4.937 (125.40)	7.000 (177.80)
	6.250 to 6.500 (158.75 to 165.10)			
	6.750 to 7.000 (171.45 to 177.80)			